

# CORRAPOL<sup>®</sup>-BT

## Durable Bitumen **Corrugated Sheet** Installation Guide

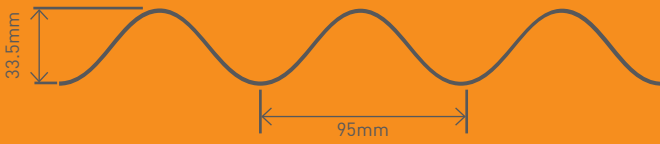

## CORRAPOL®-BT : Installation Guide



CORRAPOL-BT Corrugated Bitumen Sheet: **2000 x 930mm**

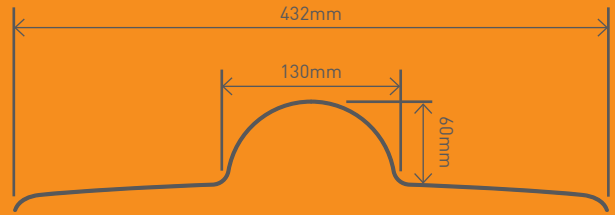

CORRAPOL-BT Corrugated Bitumen Roof Budget Ridge: **1000 x 432mm**

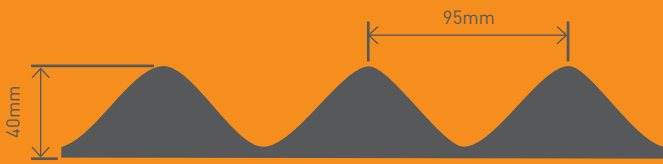

CORRAPOL-BT Foam Eaves filler: **930 x 25 x 40mm**

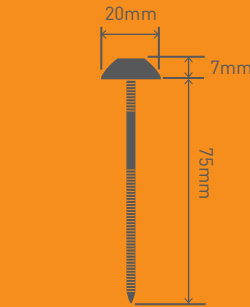

Plastic Headed Nails

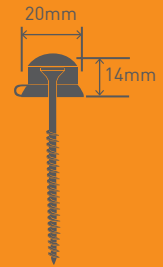

Screw Cap Fixings



CORRAPOL-BT Rock n' Lock Side Flashing



CORRAPOL-BT Super Ridge

### Tools required



Wear protective gloves and glasses.



Spray lubricating oil on a coarse toothed hand saw or use a power saw.



Fine toothed bladed Chop Saw



A hammer, cordless screwdriver/drill, tape measure and a straight edge tool.

# Installation

## 1 MEASURE the roof

**IMPORTANT** – Take all **MEASUREMENTS** of the roof so you can work out the correct plan for the sheet coverage. Allow an **extra 70mm overhang** on the slope length for the sheet overhang.

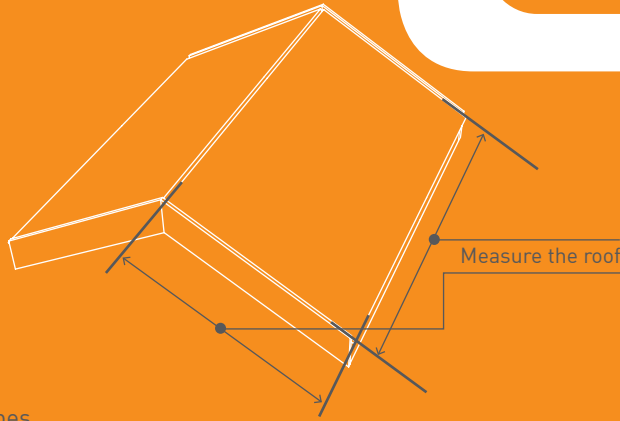

## 2 DETERMINE OVERLAPS for larger slopes

See diagrams below for overlap, depth and angle details

Fix intermediate roof supports every **two** corrugation peaks

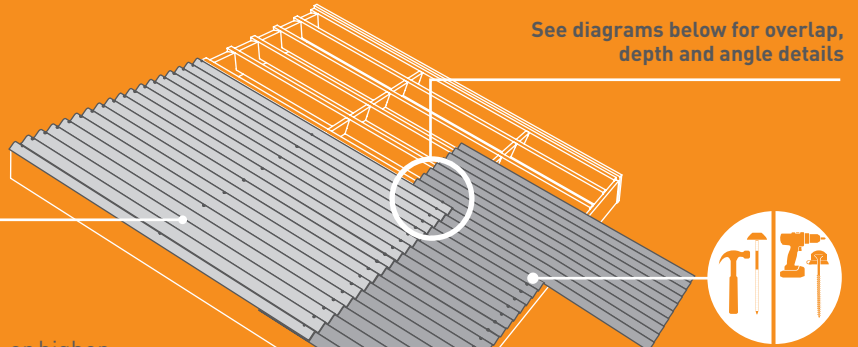
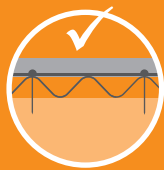

### Roof slopes of 15° or greater: Gradients of 1 in 4 or higher

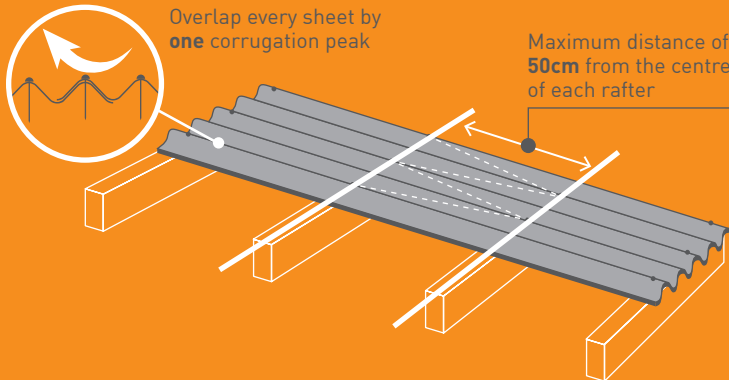

#### Overlapping sheets

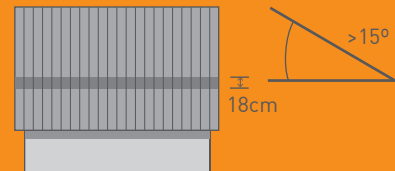

### Roof slopes of 10° – 15°: Gradients of 1 in 6 – 1 in 4

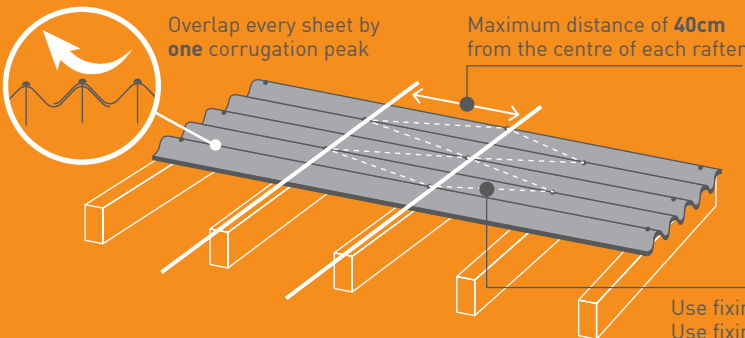

#### Overlapping sheets

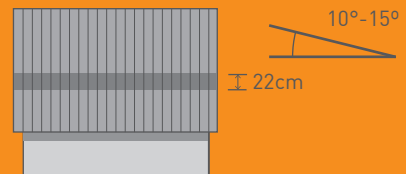

Use fixings sheets every corrugation at the eaves and sheet overlaps. Use fixings every other corrugation on intermediate purlins.

### Roof slopes of 5° – 10°: Gradients of 1 in 11 – 1 in 6

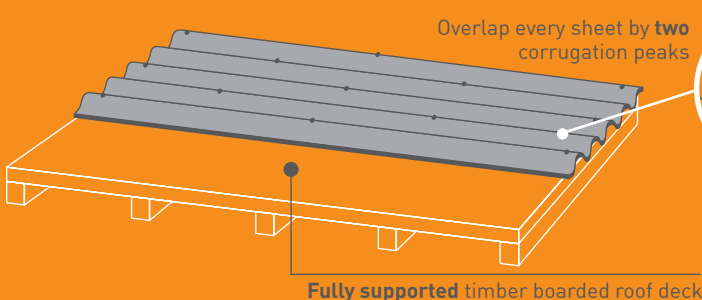

#### Overlapping sheets

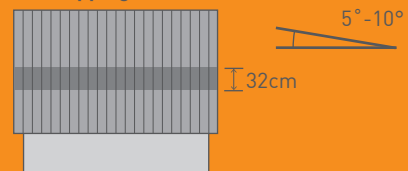

## 3 Install the CORRAPOL®-BT Foam Eaves Fillers

**IMPORTANT** – To keep the roof watertight and weatherproof, install **CORRAPOL®-BT Eaves Fillers** along fixing points of the roof.

For best performance and sealing install **CORRAPOL®-BT Foam Eaves Fillers** along the horizontal purlins and all fixing points of the roof. These will make installation easier, provide a stronger roof and give greater sealing properties from draught etc.

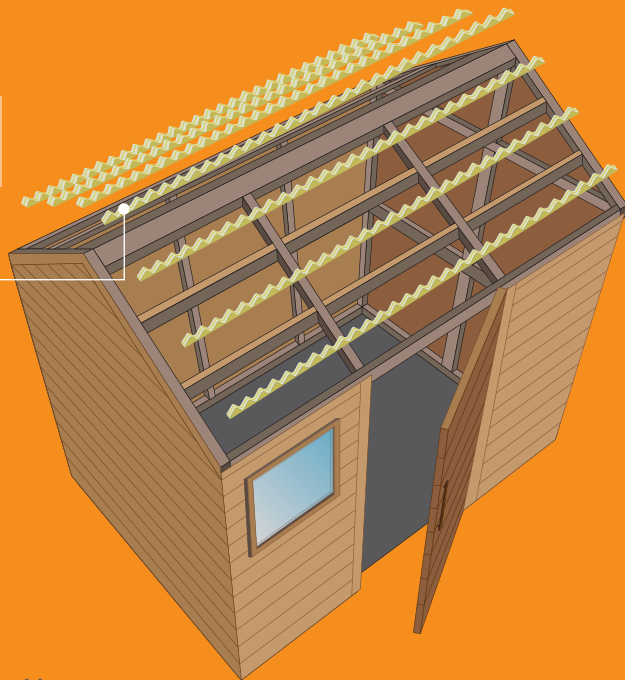

## 4 Prepare the CORRAPOL®-BT Rock n' Lock Side Flashing

**a** Cut the Aluminium **Rock n' Lock Flashing** to the required length with a chop saw which has a fine-toothed blade suitable for cutting Aluminium.

**b** Cut a mitre at the top end of the CORRAPOL®-BT Rock n' Lock Side Flashing so it finishes with a vertical end when offered up to the upper end of the roof slope.

**c** Cut the lower end of the CORRAPOL®-BT Rock n' Lock Side Flashing to the same length as the slope, **being careful to allow approximately 70mm beyond the eaves beam for an overhang.**

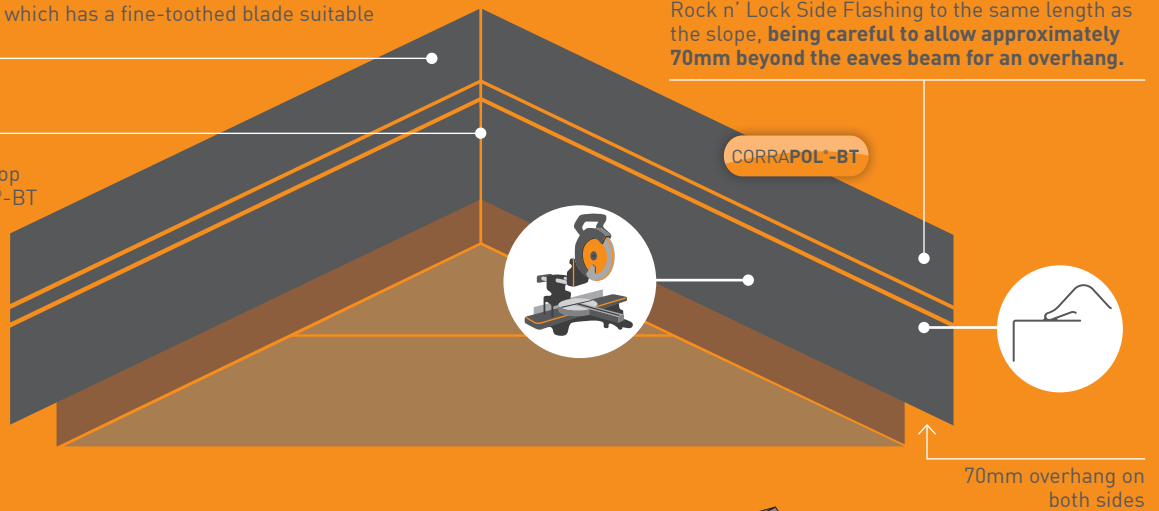

## 5 MEASURE and CUT the FIRST CORRAPOL®-BT roofing sheet

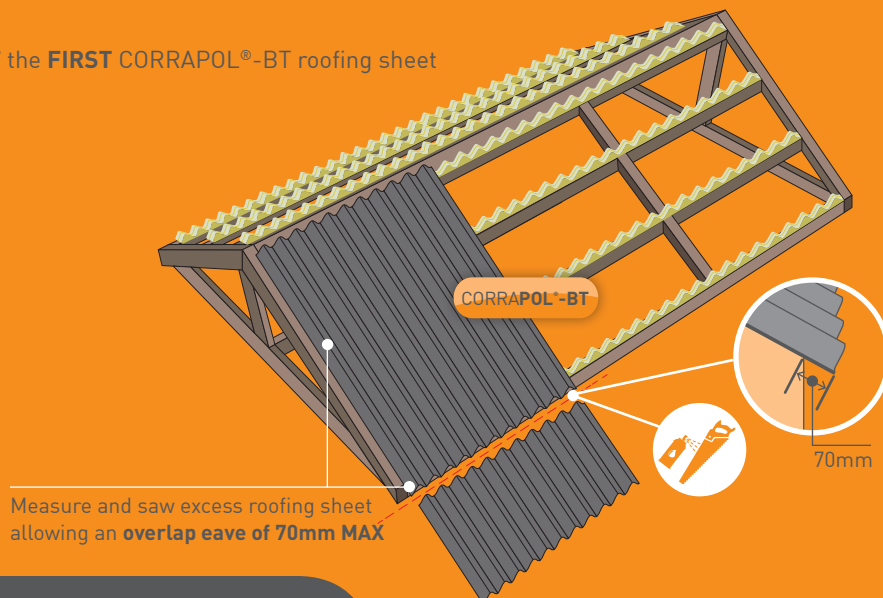

Measure and saw excess roofing sheet allowing an **overlap eave of 70mm MAX**

# 6 Install the CORRAPOL®-BT Rock n' Lock Side Flashing

**a**  
Pre-drill 5mm pilot holes approximately 250mm apart on the CORRAPOL®-BT Rock n' Lock Flashing.



**b**  
TILT the CORRAPOL®-BT Rock n' Lock Side Flashing and ROCK the first corrugated sheet peak into the curve of the flashing.

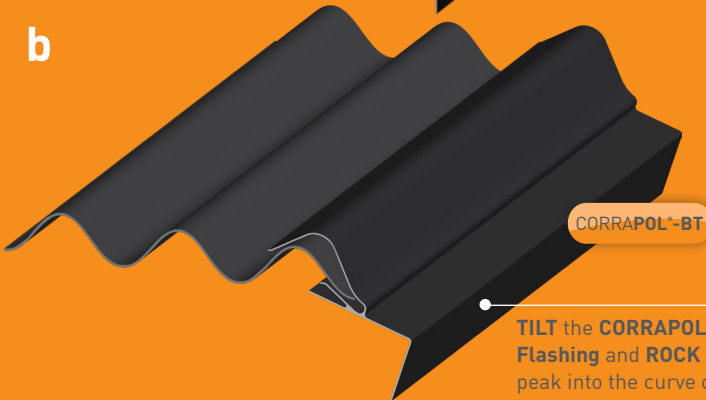

**c**  
STRAIGHTEN and LOCK the CORRAPOL®-BT Rock n' Lock Side Flashing into place giving a perfect finish to the edge of your roof structure.

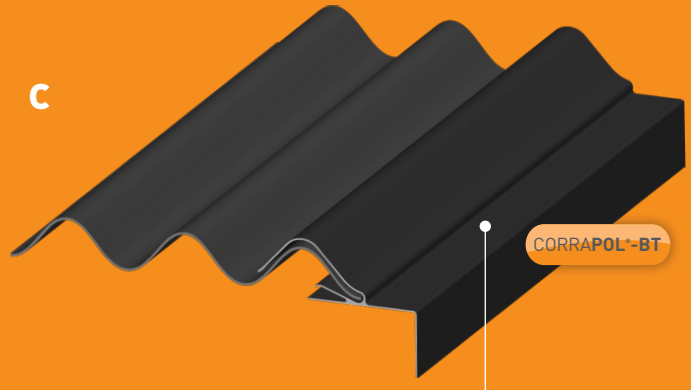

# 7 Fit the CORRAPOL®-BT Rock N' Lock Side Flashing and Corrugated Sheet

**IMPORTANT:**

- Make sure you use either the plastic headed nails OR screw cap fixings through the corrugation peak and not the trough.
- Fix the CORRAPOL®-BT Rock n' Lock Flashing with the supplied stainless steel screws and CORRAPOL®-BT screw caps

EITHER through the top OR through the side of the bar.

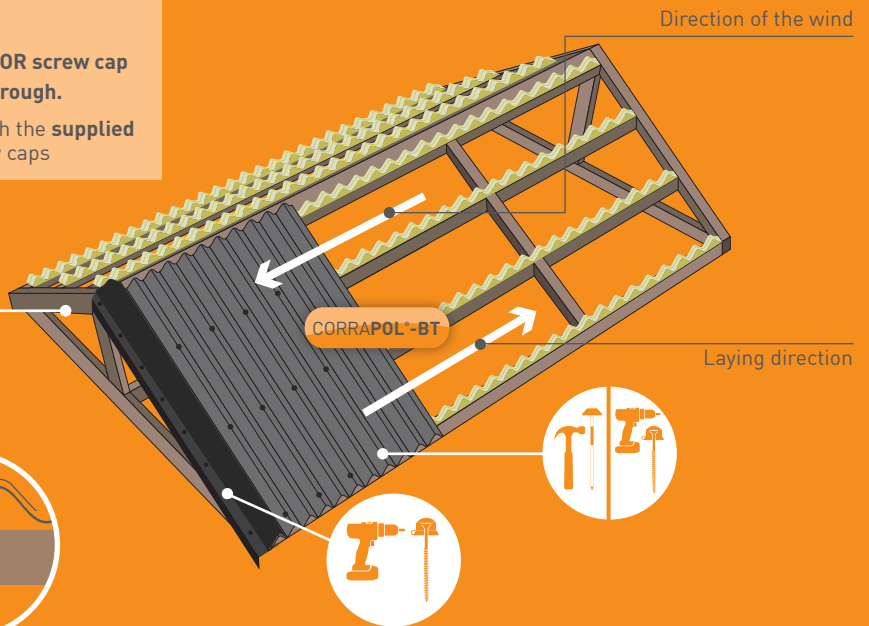
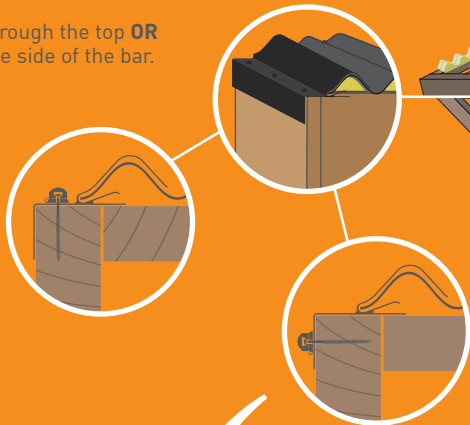

Fit EITHER the roof nails OR screw cap fixings at EVERY SECOND CORRUGATION PEAK at each of the purlins, plus the top and bottom of the roof structure.

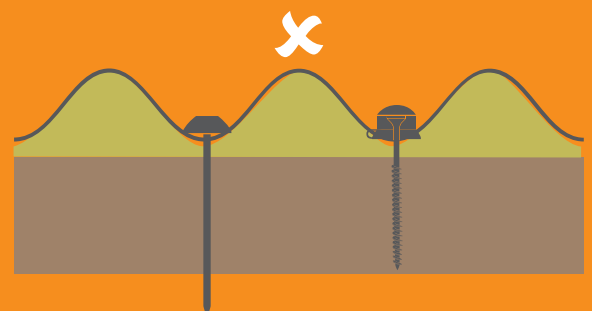

NEVER THROUGH THE TROUGH

## 8 Prepare the FINAL CORRAPOL®-BT roofing sheets

**IMPORTANT** – To avoid vertical cuts, overlap the roofing sheets by **more than two corrugation peaks** to the **EXACT MATCH** of the roof dimensions.

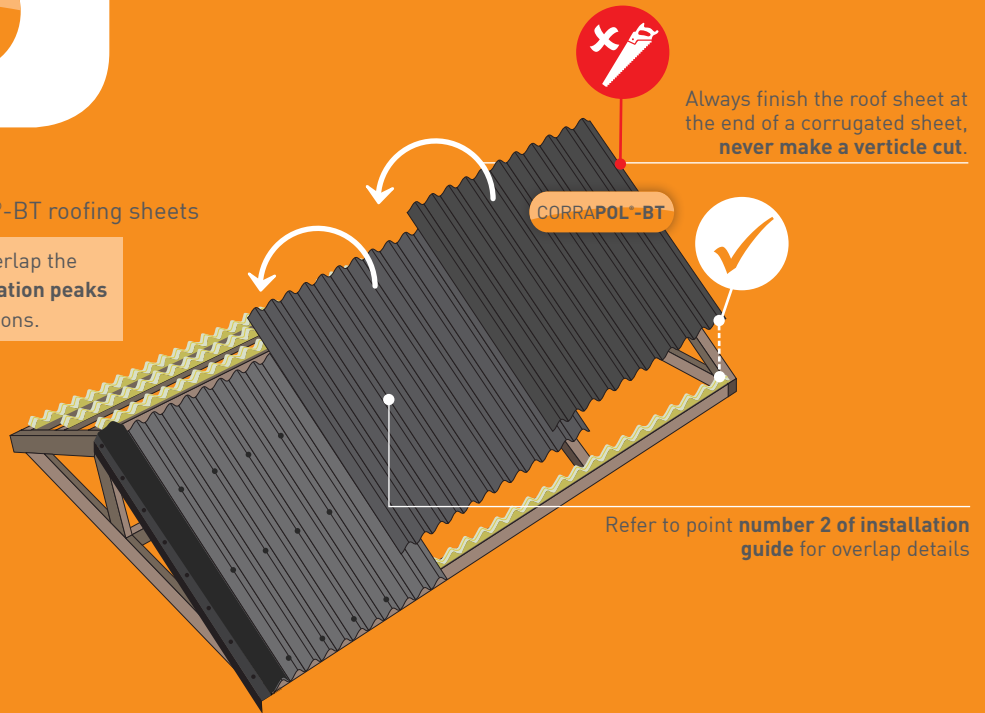

Always finish the roof sheet at the end of a corrugated sheet, **never make a vertical cut.**

Refer to point **number 2 of installation guide** for overlap details

## 9 Install all the FINAL CORRAPOL®-BT roofing sheets

Fit the remaining **CORRAPOL-BT Corrugate Sheets** plus **CORRAPOL-BT Rock n' Lock Side Flashing** as shown in part 6 to all sides of the roof.

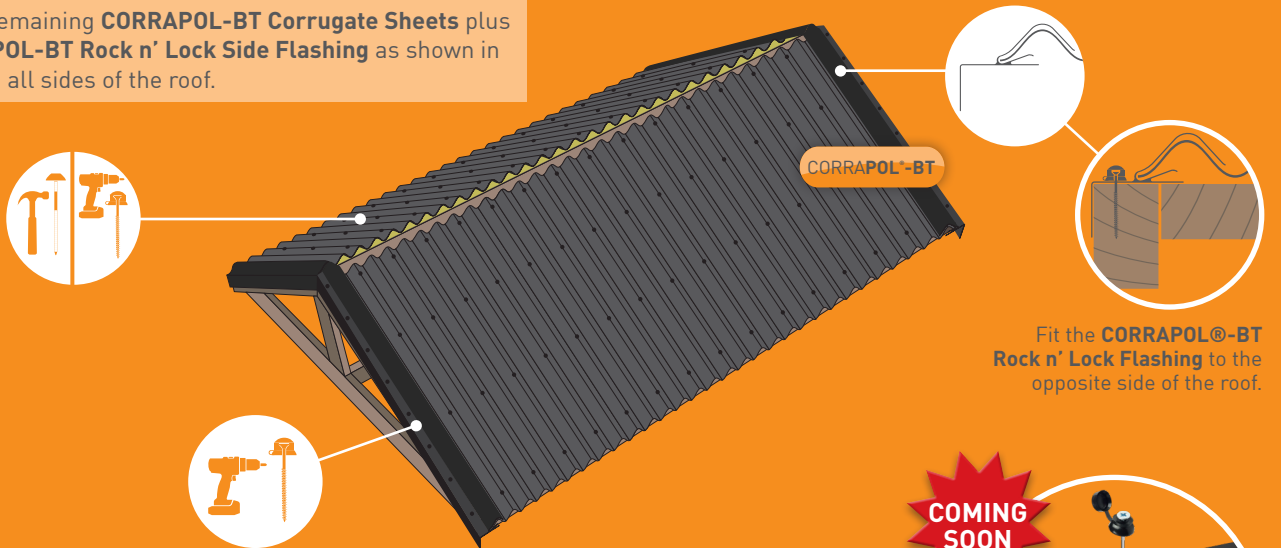

Fit the **CORRAPOL®-BT Rock n' Lock Flashing** to the opposite side of the roof.

## 10a Install the NEW CORRAPOL®-BT Super Ridge

Cut the aluminium **CORRAPOL®-BT Super Ridge** to the required length with the fine toothed bladed chop saw.

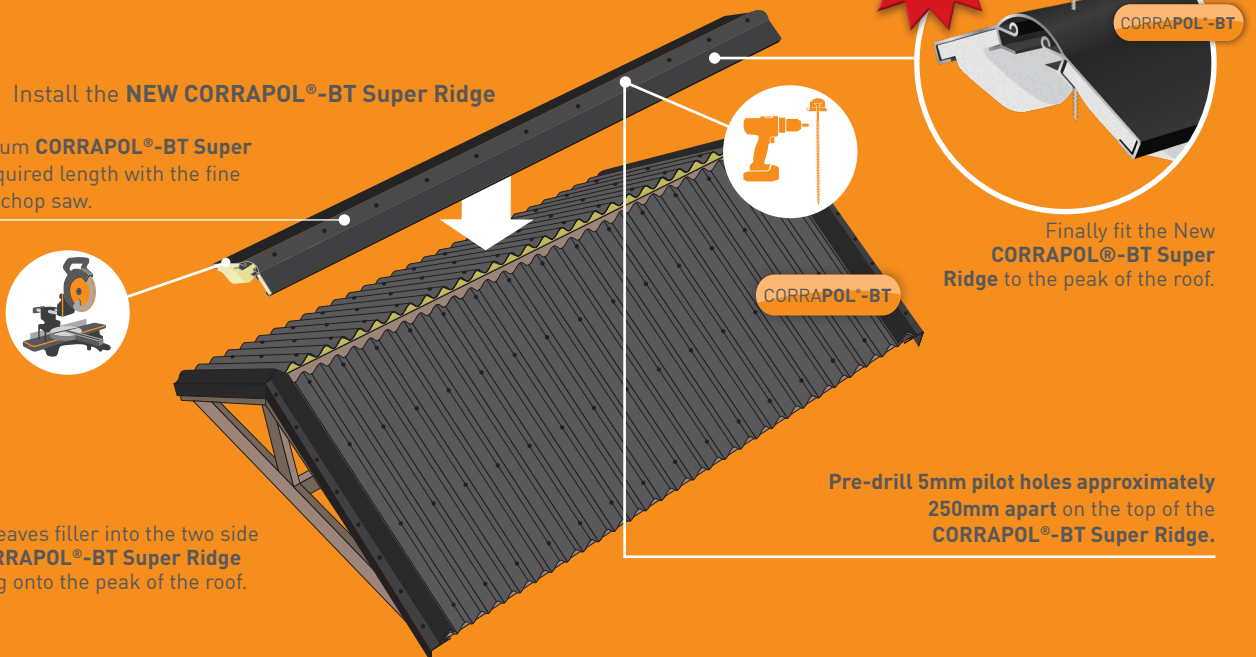

Finally fit the New **CORRAPOL®-BT Super Ridge** to the peak of the roof.

Pre-drill 5mm pilot holes approximately 250mm apart on the top of the **CORRAPOL®-BT Super Ridge**.

Slide the foam eaves filler into the two side slots of the **CORRAPOL®-BT Super Ridge** before installing onto the peak of the roof.

# 10b

Alternately install the **CORRAPOL®-BT Budget Ridge** panels

Use **nail** or **screw fixings** every **two** corrugation peaks

Overlap roof ridge panels by the minimum of 22cm

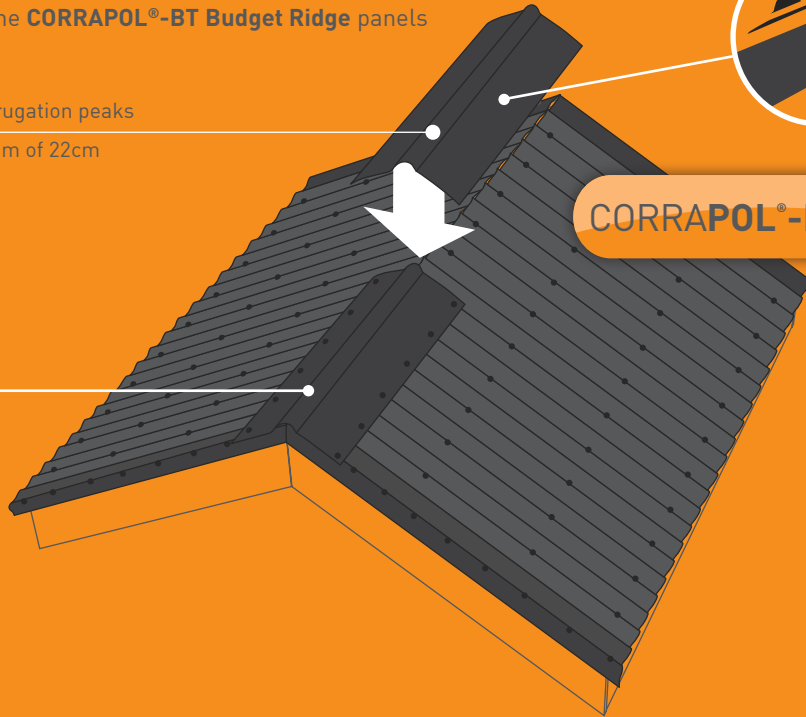

# 11

Fully fitted **CORRAPOL®-BT Roof**



---

## WARNING : REGISTERED DESIGNS & PATENTS

The IP of the designs in this brochure are protected by internationally registered design rights. Many products are also protected with active or pending Patents. Clear Amber will not hesitate to take appropriate legal action if its rights in this respect are infringed.

© Copyright – Clear Amber Group Ltd – October 2019. No part of this publication may be copied, reproduced, scanned, or stored in any electronic database, whether in whole or in part, in any form or by any means, without permission in writing from Clear Amber. Clear Amber will not hesitate to take appropriate legal action if its rights in this respect are infringed.

Inasmuch as Clear Amber have no control over the circumstances in which our material may be used, or site specific parameters, we cannot guarantee that any particular results will be achieved. Users should carry out their own tests to determine the suitability of the material for their application.